

# Sealing Solution for Steel Industry

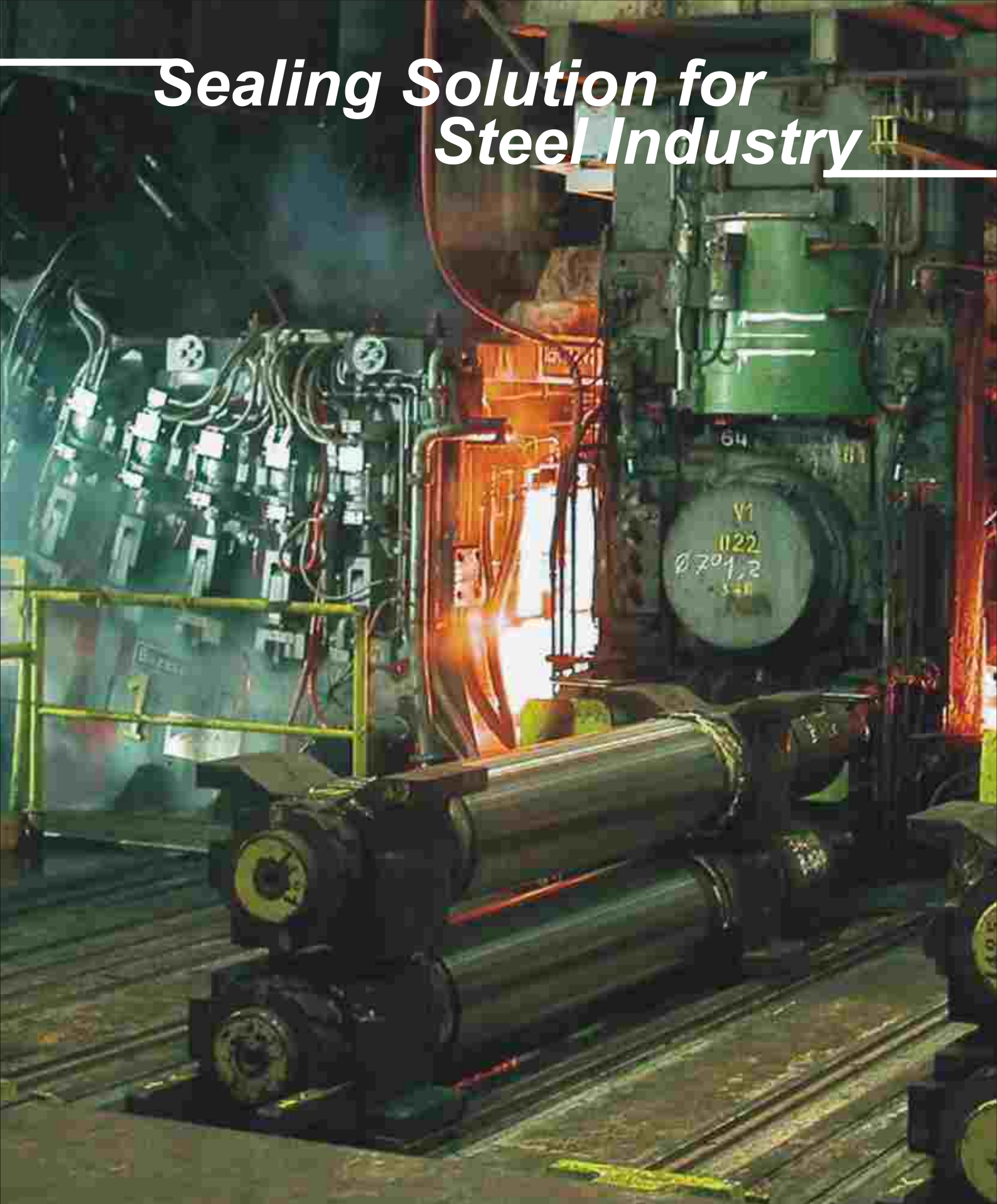

**BSCL**  
Birmingham Seals

*more than just seals...*

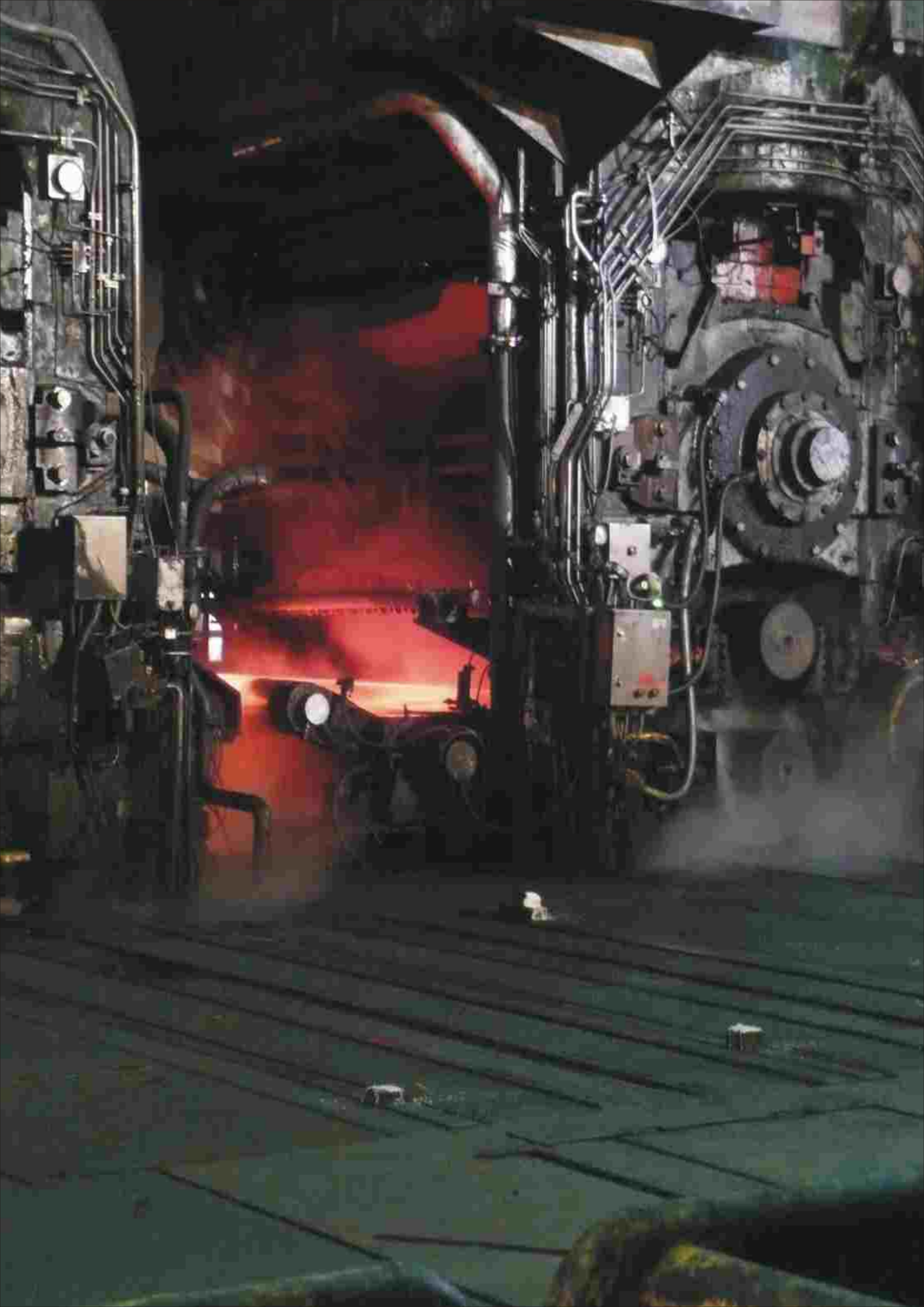



# Industry Overview

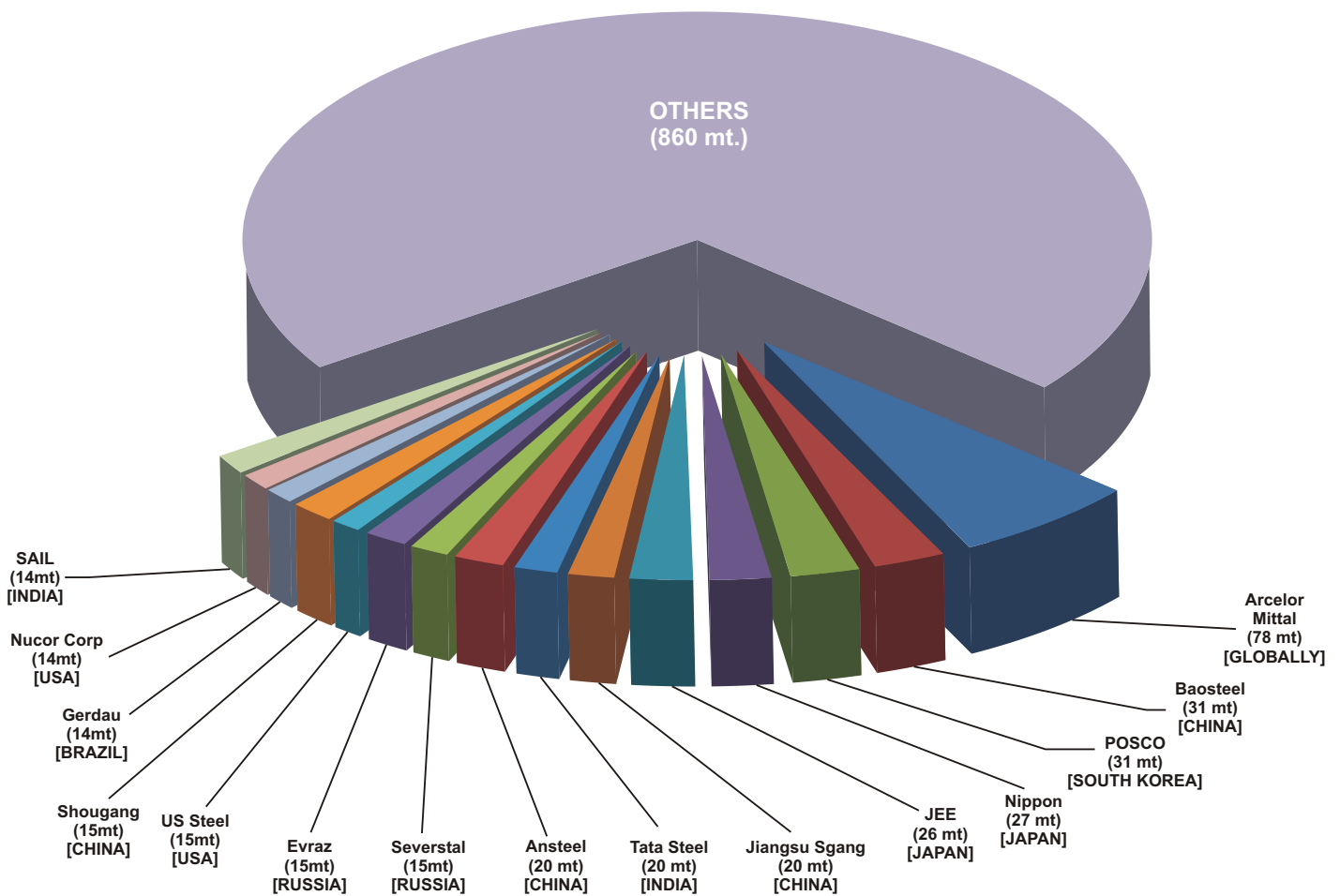

ABOVE IS AN OVERVIEW OF THE TOP COMPANIES PRODUCING STEEL

## BSCL involvement in Iron & Steel making process

Material Handling Plant  
Blast Furnance  
Coke Oven  
Continuous Casting  
Hot & Cold Rolling Mill

### Steel Products

- Hot rolled sheets
- Cold rolled sheets
- Flat products
- Galvanized sheets

### Long Products

- Long rail products
- Rolled wires
- Seamless pipes

# Steel Making Process

BSCCL Seals are present at all different stages in steel industry across the globe. Start from iron ore processing till finished coils. BSCCL has been providing technically advanced seals solutions to meet the needs of applications in these industry. BSCCL involvement starts from application study, designing, material compounding, manufacturing to installation and monitoring performance.

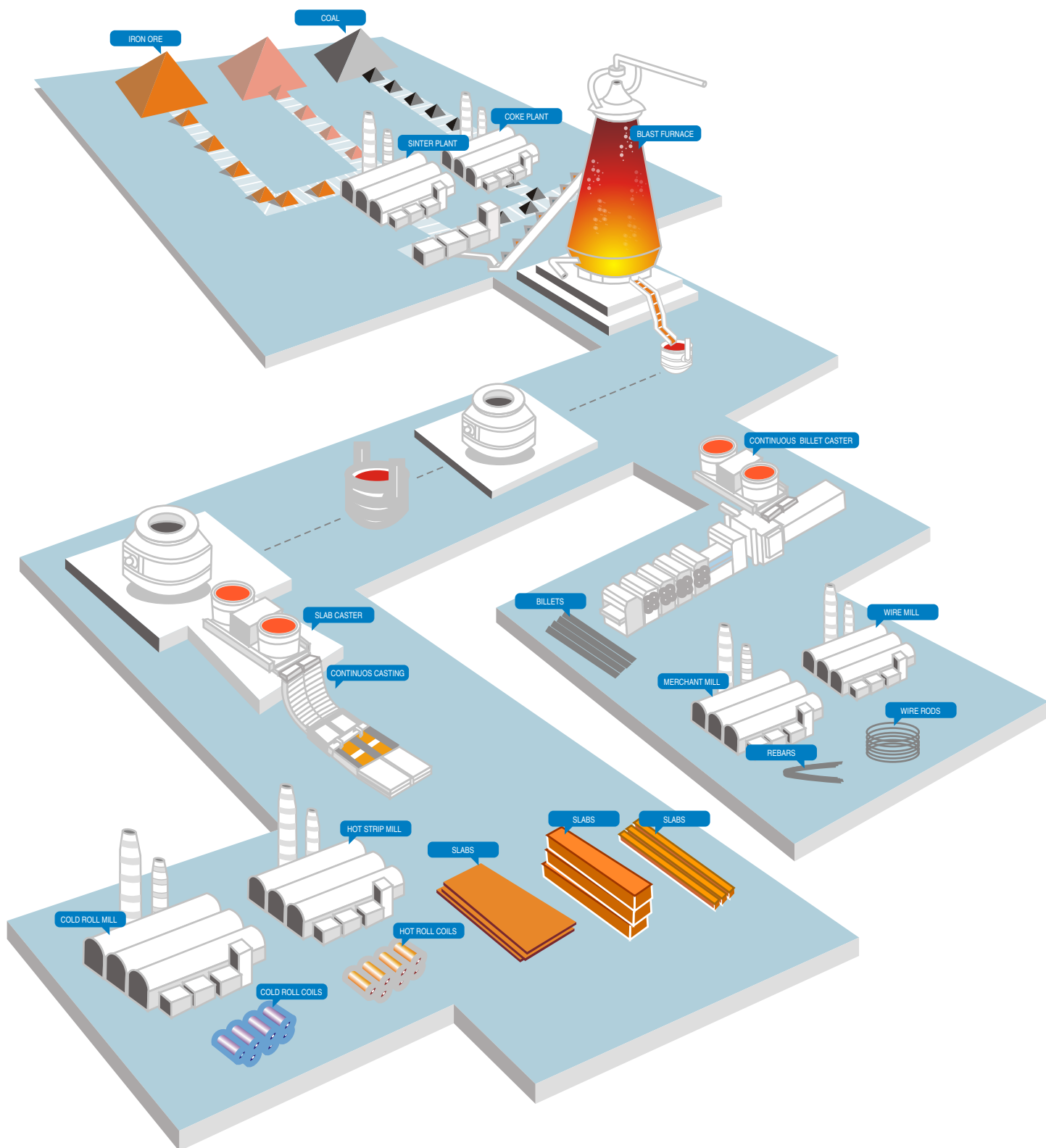

## BSCL Product Line for Steel Industry -

### Piston Seal

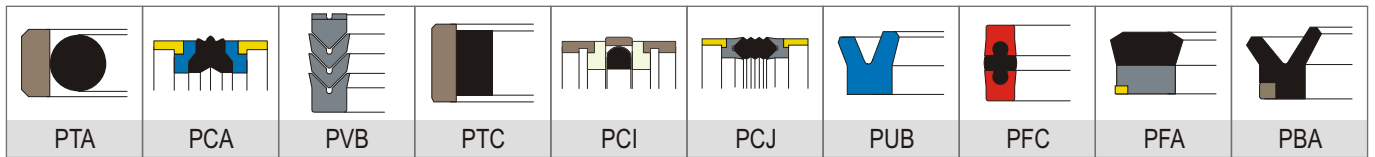

### Rod Seals

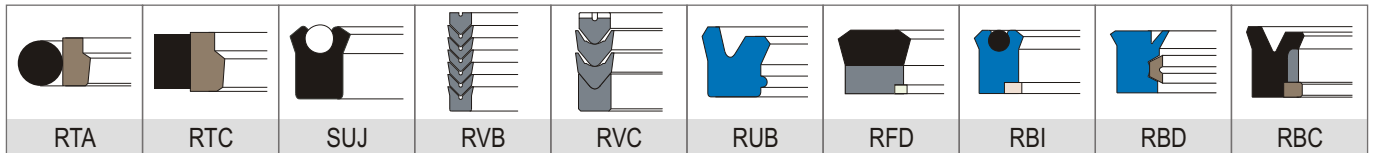

### Wiper Seals

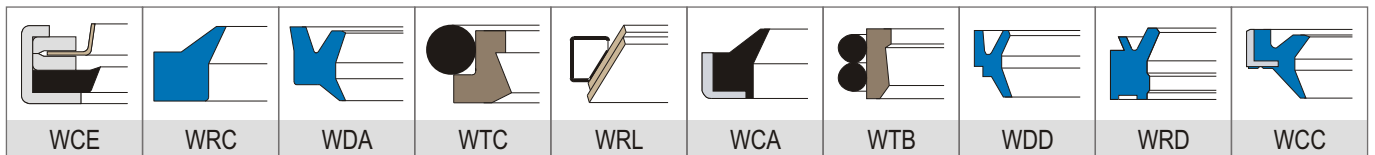

### Rotary Shaft Seals

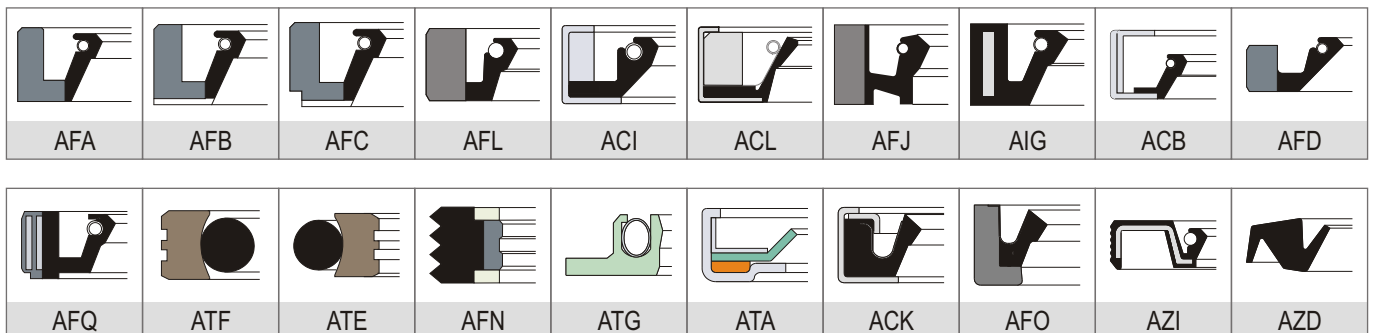

### V-Rings

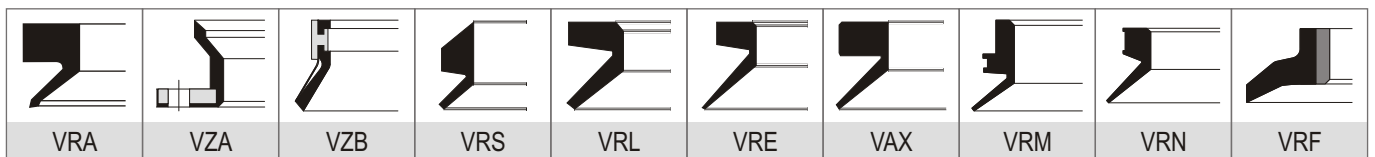

### Pneumatic Seals

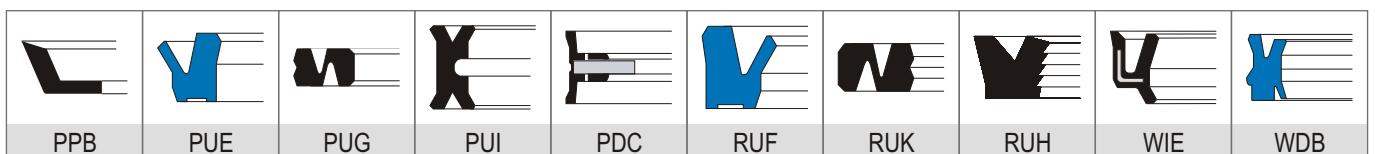

### Jet Express Seals

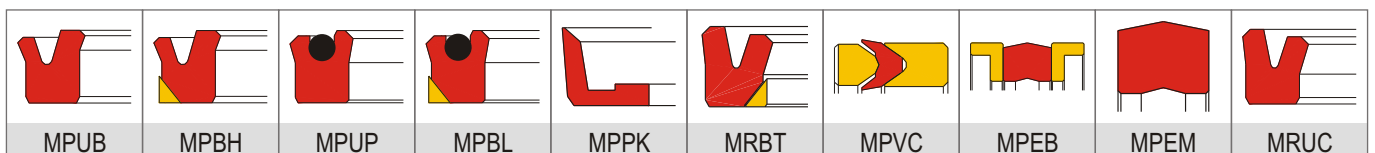

# Blast Furnace

BLAST  
FURNACE



# High Temperature Application

The hottest place in the steel making process is in the blast furnace where the seals are exposed to high temperature. BSCL had developed the seals for some of the critical equipments used in blast furnace in combination of elastomer and Teflon.



## Tap Hole Drilling

The Tap Hole drilling used for tapping the furnace hearth for casting or draining iron and slag down is exposed to extremely high temperature. Thus, replacement of standard sealing system by a special designed seal kit made of teflon & elastomer achieved extension of lifetime of the seal in working condition.

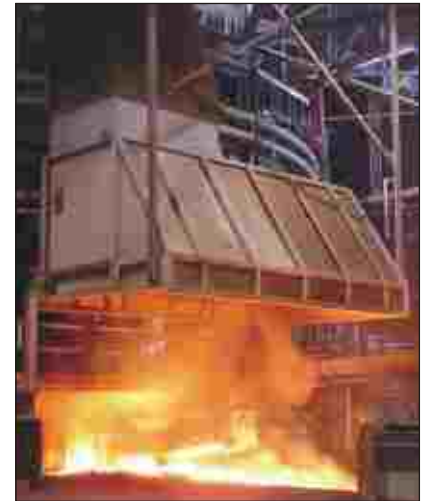

## Mudgun Ramming Cylinder

With the combination of Teflon & High Temperature resistance material, seals are developed for robust and reliable working conditions for such high end applications.

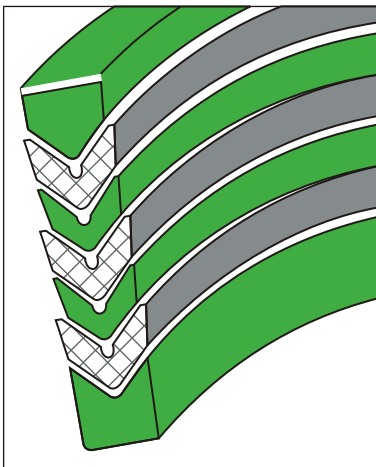

V-Packing Set consists of two support rings and two centre rings in Teflon & 3 centre rings in FKM fabric.

Working Conditions	
Pressure	400 Bar
Temperature	-40° C to +250° C
Speed	1 mtr/sec





# Coke Oven

Coke  
Oven



# High Temperature Application

For one of the critical application in coke oven where the reliability is most concern, BSCL had developed sealing profile in combination of elastomer and Teflon which achieved a tremendous extension of the lifetime of the seal.



## Converter

Dismantling equipment and replacing seals is time consuming and therefore expensive. BSCL offers its split seal range for such applications which reduces down time and production loss.

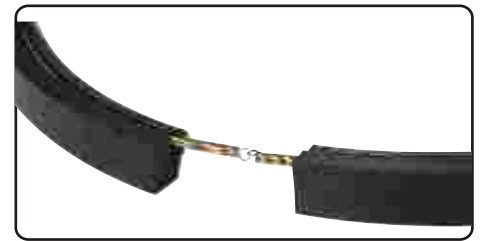

BSCL had developed Split Seals which enables to reduce down times for replacing the seals with its range of profiles with combination of rubber fabric material.



## Continuous Casting

Continuous Casting Plant is operating 7 days a week. Thus required reliability of seals. Shutdown of this process leads to high production losses.

BSCL offers high end Rubber & Thermoplastic Material in combination of seal profile which given optimum life of the seals in working condition.

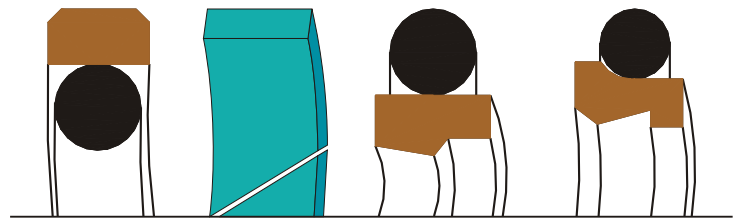

Sealing system for Guide Segment Hydraulic Cylinders in CCP

Working Conditions	
Pressure	400 Bar
Temperature	-40° C to + 250° C
Speed	10 mtr/sec

# Hot & Cold Rolling Mill

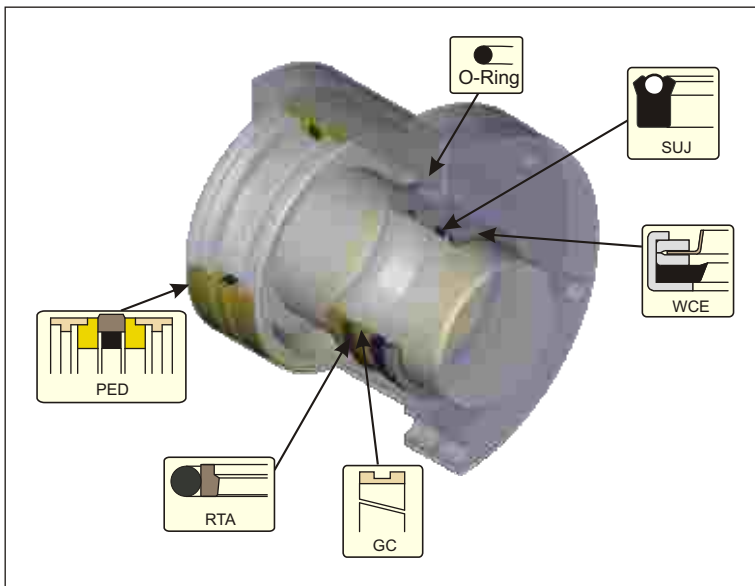

## BSCL Sealing System for Work Roll Bending Cylinder / Back-up Roll Balancing Cylinder

Working Parameters	
Pressure	Upto 300 Bar
Temperature	-30° C to +100° C (Viton matl. upto +220° C)
Speed	1 mtr/sec
Size Range	Upto 7"

## BSCL Sealing System for Hydraulic Automatic Gauge Control (HAGC) Cylinders

### Scope of Developments -

- In house modifications for existing grooves
- Long Term effective solutions
- Standard Size
- Cost Saving

### Features -

- High Load Bearing Rings
- Very Low Friction. No Stick-Slip
- Proven Design
- Heavy Duty Seal Profile Construction
- Long Service Life.
- Easy Installation

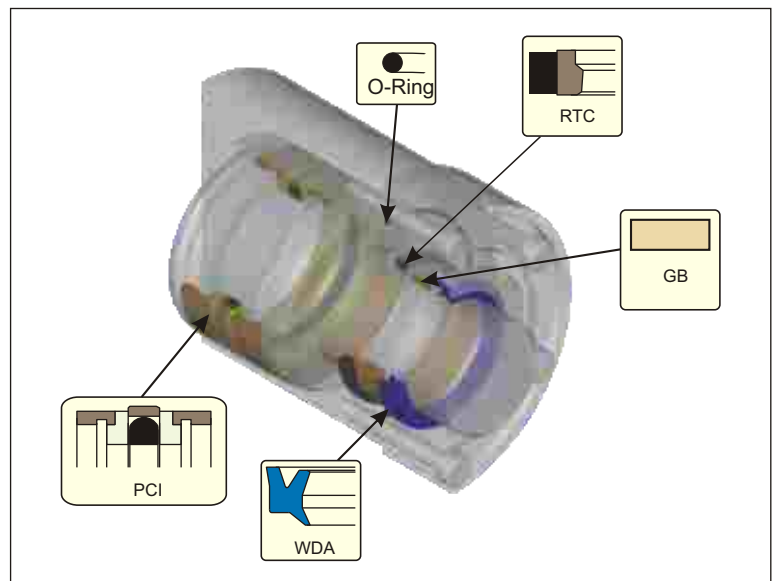

Working Parameters	
Pressure	Upto 500 Bar
Temperature	-30° C to +100° C (Viton matl. upto +220° C)
Speed	1 mtr/sec
Size Range	20" to 60"

# Hot & Cold Rolling Mill

## BSCCL Sealing System for Roll Shop Work Rolls and Back-up Rolls

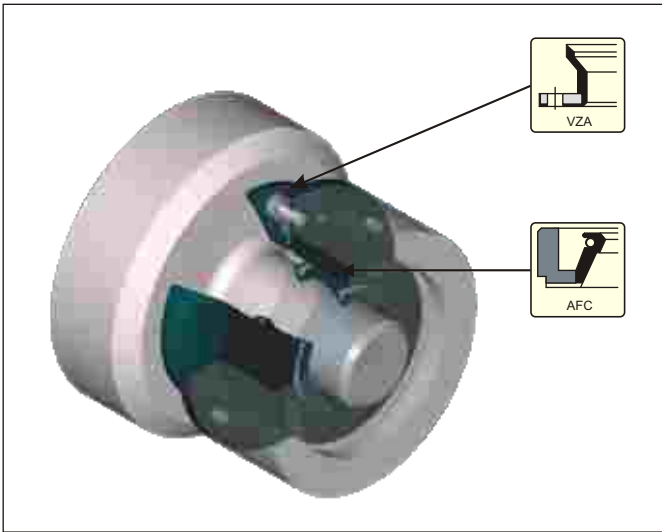

Working Parameters			
	NBR	HNBR	FKM
Temperature	-30° C to +100° C	-30° C to +140° C	-40° C to +220° C
Speed	10 m/s	15 m/s	20 m/s
Size Range	1" to 40"		

Working Parameters			
	NBR	HNBR	FKM
Temperature	-30° C to +100° C	-30° C to +140° C	-40° C to +220° C
Speed	20 m/s	25 m/s	30 m/s
Size Range	5" to 60"		

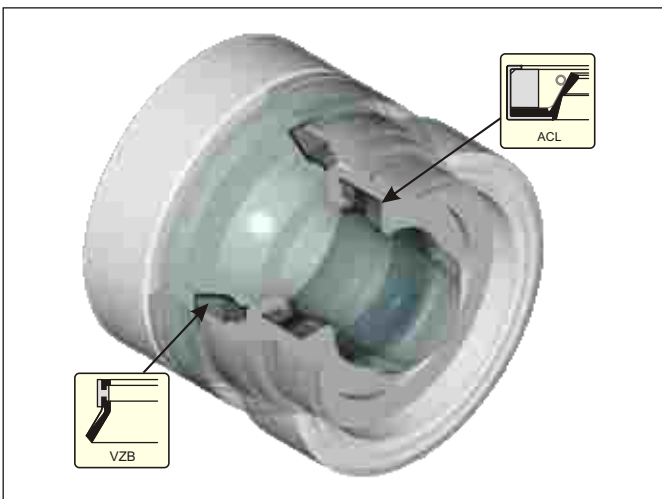
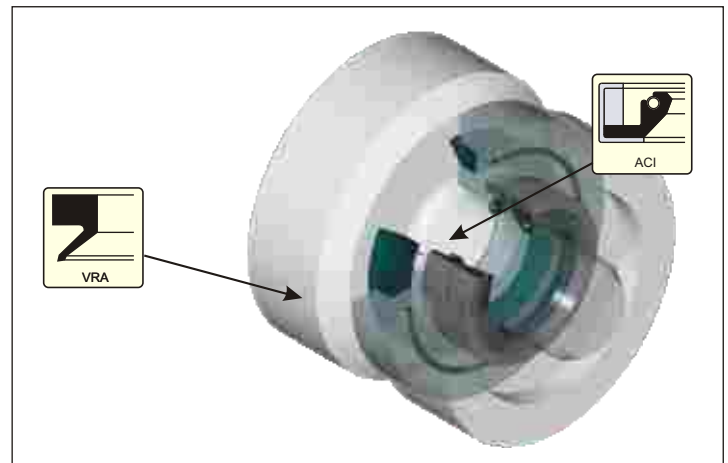

Working Parameters			
	NBR	HNBR	FKM
Temperature	-30° C to +100° C	-30° C to +140° C	-40° C to +220° C
Speed	30 m/s	32 m/s	35 m/s
Size Range	10" to 60"		

(Given Speed Values may vary depending upon actual working parameters)

# Application Overview

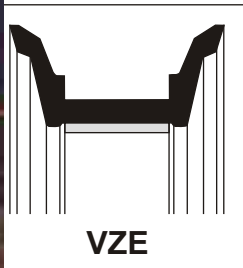

## FRONT VAVLE SEALS

This seals are developed in WRM for module. Specially design sealing element with steel band offers high wear resistance and excellent performance.

- Speed - 2 mtr/sec
- Size Range - 4", 6" and 8"

## NECK SEALS

BSCCL had developed Neck Seals for domestic and international steel industries. This neck seal series is available in both ANA & ANB style to meet customers requirement. With the special material compound and stringent manufacturing process this neck seal had proven good performances and optimum service life.

Every size of neck seal can be supplied along with its corresponding watergard seal or the single neck seal and watergard seal.

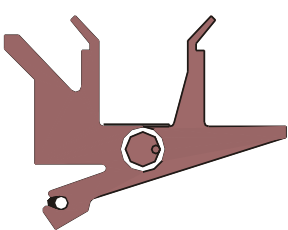
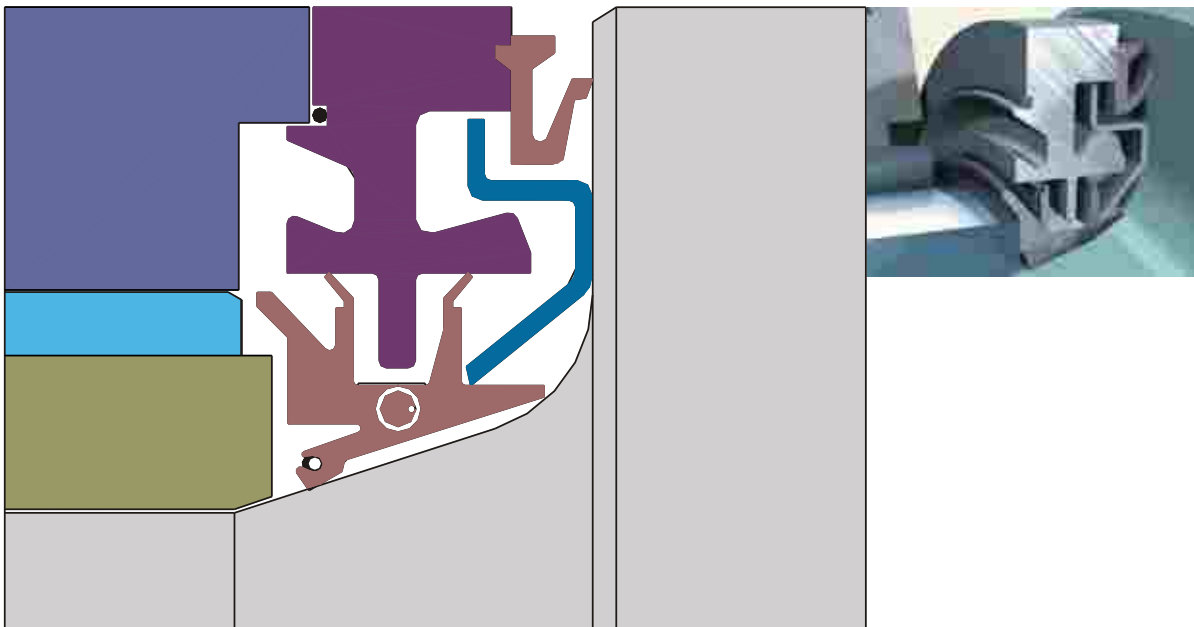

TYPE:- ANB

Developed Sizes -  
12", 16", 21",  
44", 46", 48", 50"

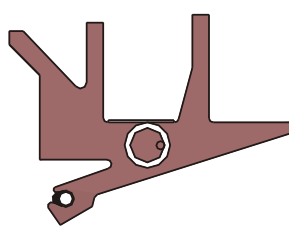

TYPE:- ANA

Developed Sizes -  
10", 14", 16", 18",  
24", 48", 50", 54"

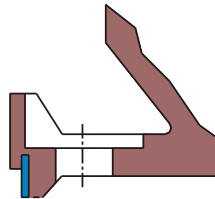

TYPE:- WATERGARD

# Application Overview

## Taper Roller Bearing Seals -

BSCL had developed inner & outer seals for Taper Roller Bearings used in work roll and intermediate roll chocks. AZI & AZZ seals are constructed with a metal insert with rubber covered outer diameter. Spring loaded single and dual lip made out of FKM or HNBR elastomer.

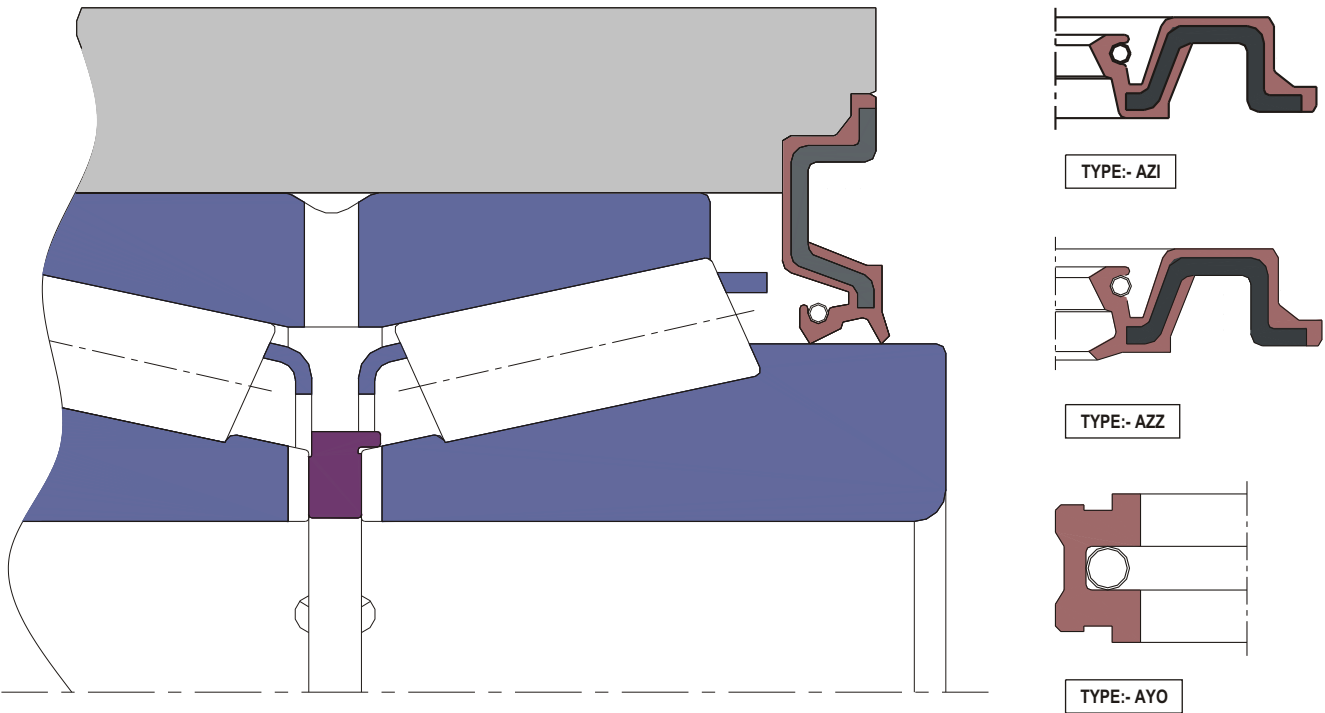

\* Assembly shown is just for an example purpose, it may vary to the actual bearing assembly.

## Special seals for different application in steel making process -

BSCL is involved in supplying specially developed seals in various applications in different stages of steel making process. Seals for valves, actuators, accumulators, rolling mills, furnace equipments are supplied in different elastomer materials. The size range of these seals are covered upto 2 mtr. in diameter. You can place your trust on BSCL for these kinds of special requirements.

<p>Location : Pellet Plant Description : Sealing ring for discharger air sealing of HBFS 120/10 Size : Ø1500.00 mm</p>	<p>Location : Rolling Mill Description : Oil seal for model Y for R2 work roll chock assembly Size : Ø900.00 mm</p>	<p>Location : Coke Oven Description : Piston seal for stove accumulator Size : Ø350.00 mm</p>	<p>Location : Blast furnace Description : Seal for lower seal valve Size : Ø1000.00 mm</p>	<p>Location : Blast Furnace Description : Bleeder Valve Seals Size : Ø800.00 mm</p>

# Success Stories

## Development of Topguard: -

BSCL is offering customised sealing solution in steel mill according to the requirement and encountering the problems by giving best sealing solution without doing major modification in existing assembly. Below shown design is one of an example of such development.

**Old Design**

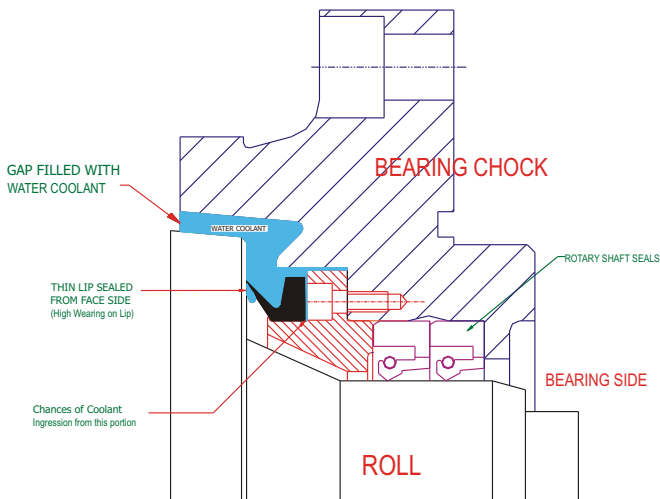

**New Design**

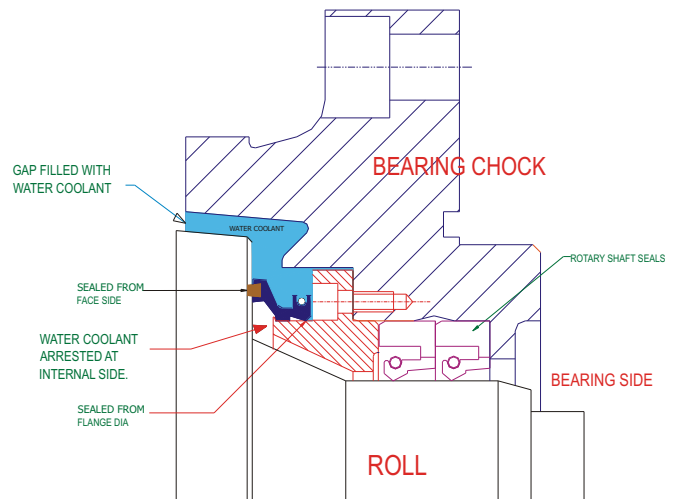

**BSCL proposed assembly with new developed TOPGUARD coolant seal**

**Old Design V-Ring Concept**

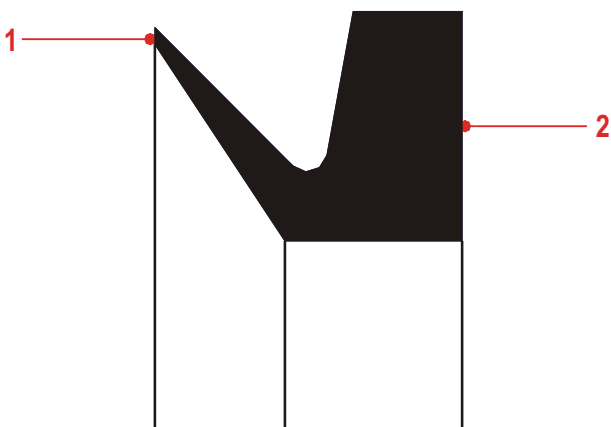

1. Thin Lip surface in contact with roll face
2. Flat body contact with uneven surface of flange

**New Design TOPGUARD Concept**

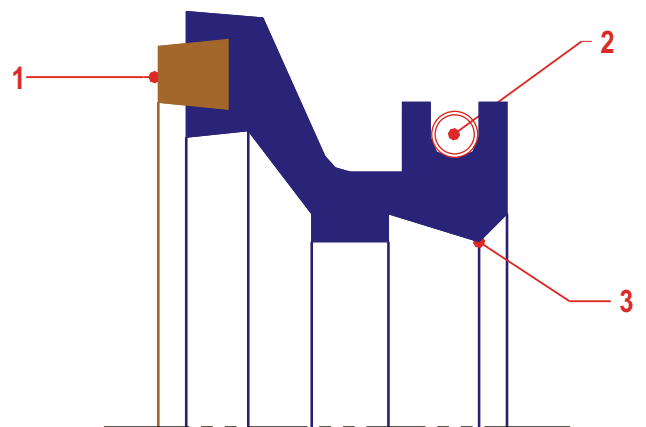

1. Bronze filled PTFE insert Lip for good wear resistance
2. Spring to hold the Lip tight on flange
3. Sealing lip profile to seal coolant from opposite side

## Development of Sealing Solutions for Backup Roll: -

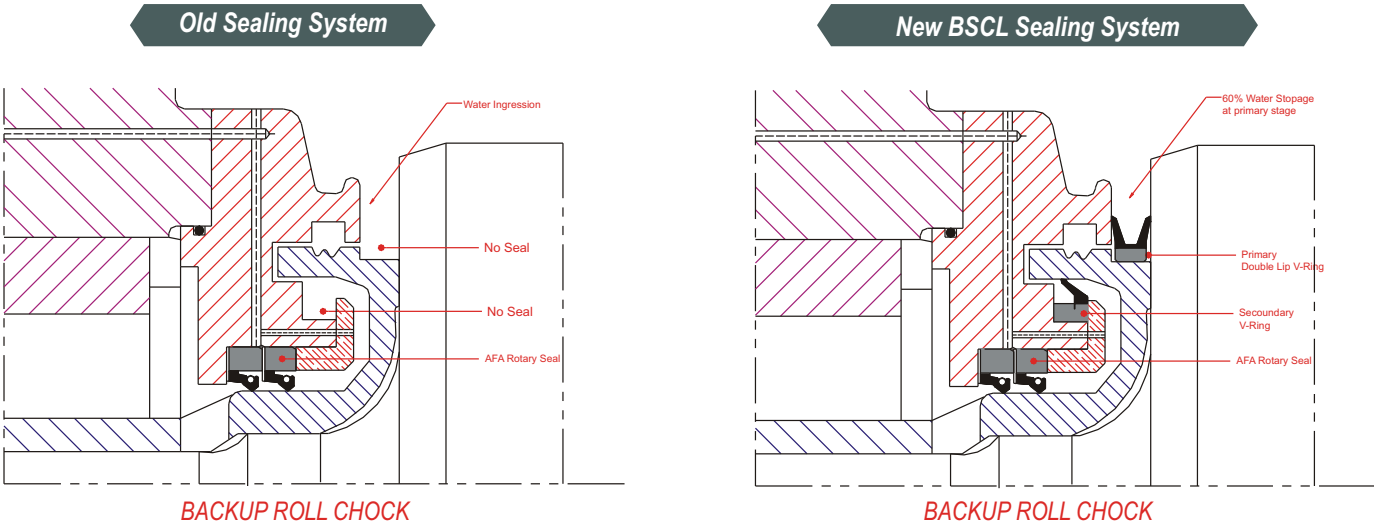

Above is an example of development in one of the steel mill done by BSCL which had proven the performance and drastically reduced the ingress of coolant into the bearing and had increased the life & performance of an expensive bearing.

## Development of Customised Profile: -

Highlights :-

BSCL has developed sealing solutions for Hydraulic and Rolling Mills for Steel Industry by offering customized sealing concepts to overcome the existing problems by developing new sealing profiles with suitable material according to the working parameters. The below given seals profiles are some of the examples developed.

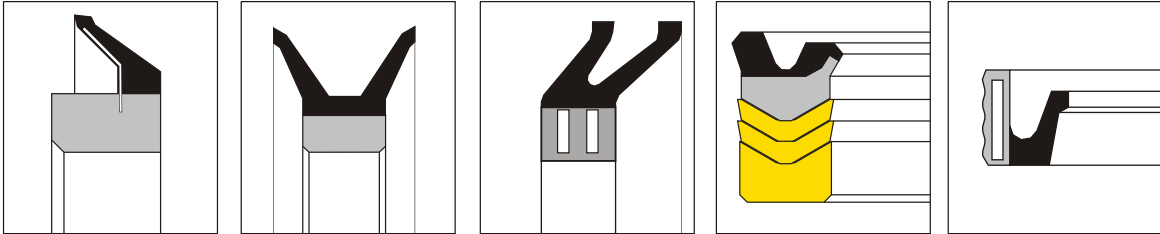

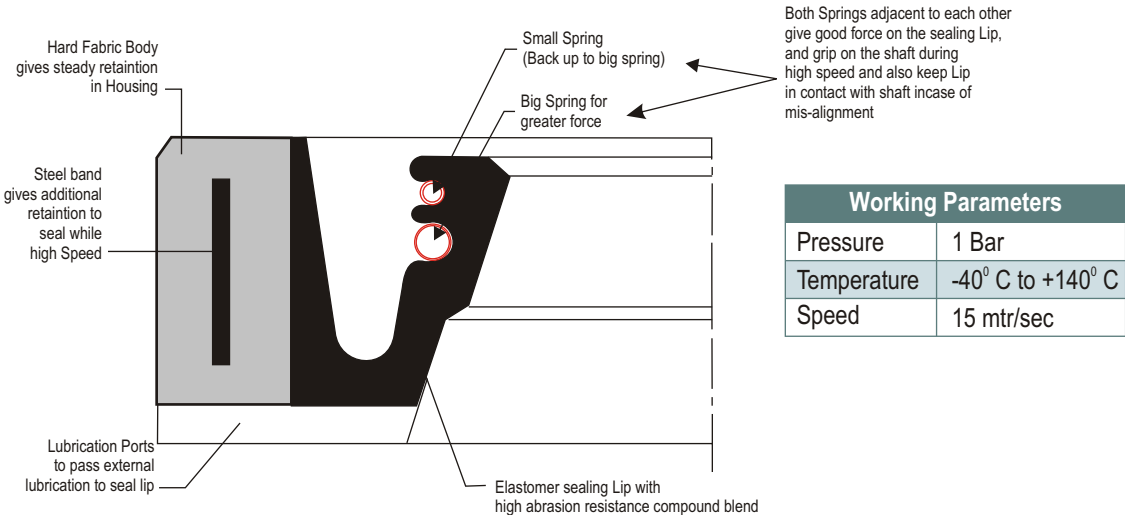

## Force - 2K10 type Rotary Seal for Backup Roll Chock. (Hot Rolling & Cold Rolling Mill)





# Seal Material

## Elastomers

Materials (Commonly known as)	Material Description	Temp. Range
 <b>Nitrile</b>	Acrylonitrile Butadiene Rubber (NBR)	-40° C to +100° C
<b>Viton®</b>	Fluro Rubber (FKM)	-40° C to +220° C
 <b>Silicon</b>	Silicon Rubber (VMQ)	-70° C to +200° C
<b>EPDM</b>	Ethylene Propylene Diene Rubber	-40° C to +120° C
<b>Neoprene®</b>	Chlorobutadiene Rubber (CR)	-20° C to +100° C
<b>VAMAC®</b>	Polyacrylic Rubber (ACM)	-10° C to +125° C

### Acrylonitrile Butadiene Rubber (NBR)

Hardness	BSCL Code
NBR 70°/75° Shore 'A'	NT4/b
NBR 80°/85° Shore 'A'	NT5/b
NBR 90°/95° Shore 'A'	NT6/b

Commonly known as **NITRILE** or **BUNA-N**.

Nitrile rubber is the sealing material most frequently used in Hydraulic & Pneumatic systems because of its excellent resistance to mineral oil based fluids, greases, water & hydrocarbon fuels. It has good physical characteristics such as abrasion resistance and good compression set.

NBR is not suitable to Aromatic hydrocarbons, chlorinated hydrocarbons, automotive brakes fluids, and some fire resistant hydraulic fluids.

### Hydrogenated Acrylonitrile Butadiene Rubber (HNBR)

Hardness	BSCL Code
HNBR 70°/75° Shore 'A'	NT42/a
HNBR 80°/85° Shore 'A'	NT42/b
HNBR 90°/95° Shore 'A'	NT34











**HNBR** has good heat resistance, oil resistance & resistance to number of aggressive chemicals. The material exhibits high mechanical strength and improved abrasion resistance. It also has superior resistance to weathering, ozone and hot air and very good resistance to technical oils, even in the presence of hydrogen sulphide and amines.

### Polyurethane (PUX)

Hardness	BSCL Code
92°	PUX

**PUX** material is a special grade polyurethane capable to withstand temperature upto +110°C, compared to normal grade PU material. Besides temperature resistance it exhibits good wear & tear properties, abrasion resistance, extrusion strength and good flexibility.

## Thermoplastics & Thermosets

Materials (Commonly known as)	Material Description	Temp. Range
 <b>PU</b>	Polyurethane	-30° C to +100° C
 <b>Teflon®</b>	Polytetrafluorethylene (PTFE)	-200° C to +260° C
   	PTFE Compounds (Bronze / Glass / Carbon / Graphite)	-200° C to +260° C
 <b>TPE</b>	Polyester Elastomer	-50° C to +110° C
 <b>PF</b>	Phenolic Resin Bonded Fabric	-20° C to +120° C
 <b>Delrin®</b>	Polyacetal (POM)	-40° C to +140° C
 <b>G.F. PA66</b>	Glass Filled Polyamide (Nylon)	-20° C to +220° C
 <b>PEEK</b>	Polyetherether Ketone	upto +315° C

### Fluro Rubber (FPM)

Hardness	BSCL Code
FPM 70°/75° Shore 'A'	VT2/b
FPM 80°/85° Shore 'A'	VT3/b
FPM 90°/95° Shore 'A'	VT4/b

**FPM** Rubber is commonly known by DU PONT trade name **VITON**. The main characteristics of FPM are that it is resistant to high temperature & their chemical stability. Also displays minimal weight loss in high vacuum & also, its permeability to gases is low.

**VITON** is compatible to fire resistant Hydraulic fluids, hot oils, greases, hydrocarbon, chlorinated hydrocarbons & most organic acids, even at high concentrations and with / against a number of organic compounds. It has excellent resistance to hot water and to steam.

FPM, however is not resistant to methanol, ketones, esters and ethers.

### HNBR with PTFE Filler

Hardness	BSCL Code
HNBR 80°/85° Shore 'A'	NT34/b

This specially developed compound is very good for low friction and low abrasion resistance. Mostly this material are used for seals subjected to dry run.

### Polyamide (Nylon)

Hardness	BSCL Code
M 95°	NY-X

**NY-X** grade polyamide have capability to withstand temperature upto +290°C compare to other grade polyamide. It has good slide and wear characteristics. The materials are continually resistant to solvents, grease, fuels, oils and acids. Strong acids, alkalis and hot water attack polyamide.





**Our Esteemed Customers:**



Arcelor Mittal (Germany)



Thyssen Krupp Steel (Germany)



Tata Steel



JSW Steel



Steel Authority of India (SAIL)



Essar Steel



Bhushan Steel



Uttam Steel

**Birmingham Seals Co Limited**

Unit 31 Regal Drive, Walsall Enterprise Park Wednesbury Road, Walsall WS2 9HQ  
 Tel: 01922 646716 / 0845 4501585 • Fax: 01922 634259 / 0845 4501584  
[www.birminghamseals.co.uk](http://www.birminghamseals.co.uk)